

airplex

4x4, car & truck accessories



Fit My Vehicle

- Vehicle Make -

-

-

SEARCH

100% KIWI OWNED & OPERATED



SINCE 1982



The leading manufacturer & distributor of:
Ute, Truck & Car accessories in New Zealand

Airplex Industries Ltd | www.airplex.co.nz

21 Saleyards Rd, Otahuhu, Auckland 1062 | PH: 0800-247-753 | E: info@airplex.co.nz

Table of Contents

Ute Lids, Canopies & Covers

- 3** Hard Lid - Alloy
- 4** Hard Lid - Rolling Lid
- 5** Canopy - Steeltop
- 6** Canopy - Venture
- 7** Canopy - SmartCap
- 8** Hard Cover - Tri-Fold
- 9** Soft Cover - Tonneau

Accessories

- 25** Exterior Body Trims & Grills
- 26** Fender Flares
- 27** Seat Covers
- 28** Bonnet Guards
- 29** Headlight Guards
- 30** Weather Shields

Bars and Roof Racks

- 10** Sports Bars
- 11** Nudge Bars
- 12** Winch Bars
- 13** Tow Bars & Wiring Looms
- 14** Side Steps / Running Boards
- 15** Tub Rack
- 16** Roof Racks
- 17** Roof Rack Accessories

Electrics

- 31** Throttle Controller -EVC iDrive
- 32** Lighting - Light bar & Spot lights
- 33** Tailgate Assist
- 34** Tailgate Central Locking
- 35** Promotional Items

Ute Bed Accessories

- 18** Ute Bedliners
- 19** Well-Side Rail Caps
- 20** Bed Mats & Floor Mats
- 21** Slide Trays
- 22** Universal Drawers
- 23** Bed Extender
- 24** Swing Cases

Heavy Truck Products

- 36** Stone Guard
- 37** Sunvisor (exterior)
- 38** Air Deflector & Side Kits
- 39** Wheel Trims

PROUDLY 
MADE IN NZ



HARD LIDS

ALUMINIUM CHECKERPLATE

BUILT TOUGH TO WORK AND PLAY AS HARD AS YOU DO!

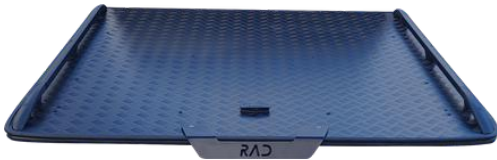

STANDARD FLAT TOP
(WITH OPTIONAL SIDE RAILS)



TO SUIT SPORTS BAR
(SPORTS BAR SOLD SEPERATELY)

FEATURES:

- Laser cut to match the shape of your utes tray.
- Load rated to 200kg, our lids can handle anything stacked on top of them. Great for you tradie's out there.
- Keep your gear safe and your mind at ease. Our single lock design is one of the strongest latching's on the market.
- Our lids are water tight so your goods can stay safe through rain, hail and snow.
- Compatible with most Sports Bars
- Optional central locking available.



ROLLING LIDS

MANUAL OR ELECTRIC

Crafted from strong, durable, and lightweight aluminium, the Airplex Rolling Lid offers excellent protection for your ute's cargo, while also providing a sleek, black powder-coated finish. Plus, with both electric and manual options available for most ute models, you can choose the best option for your needs.



K type Aftermarket Sports Bar

K Type: Wide Flange model

Compatible with Airplex sports bar & some after market bars.

Available in Electric or Manual.

F Type: Sailplane model

Compatible with Factory Sailplanes
Only available for select vehicles.



F type Factory Sailplane



Y type No Sports Bar

F type: Narrow Flange model

Option for vehicle with no sports bar or sailplane.

Available in Electric or Manual.



EXECUTIVE CANOPY

DOUBLE CAB

The Airplex SteelTop® is an entirely new generation of canopies that offer a range of benefits vastly superior to the conventional plastic and fiberglass ute canopy and include an impressive list of standard features.

FEATURES

- Made from steel - just like your ute
- Central locking, synchronized to your existing key fob
- Integrated roof rails (100kg dynamic load, 200kg static)
- Baked Paint System, Colour coded
- Complete interior lining
- Interior light
- Rear window demister
- Optional tinted slide windows -available at additional cost





VENTURE

NEXT GENERATION CANOPY

DOUBLE CAB

A sleek external shell manufactured in automotive ABS materials in combination with modern features. Our aim was to deliver a canopy as much as possible dynamically integrated with the whole vehicle to come close to an appealing SUV-look, not an "add-on box" any more.

FEATURES

- Full central locking: rear door and side lift windows
- Double click on the remote control will open the rear door. Close the car and all Canopy windows are locked as well.
- Carry capacity: 100 kg Dynamic/Driving and 300kg Static
- Frameless pop up windows
- Sliding dog hatch built in to side windows (optional)
- Led Interior Lightning
- Non-Drill Clamp Fit





SMARTCAP[®]

STAINLESS STEEL CANOPY

DOUBLE CAB

Forged from 409 grade automotive stainless steel, the SmartCap canopy is arguably the strongest ute canopy ever designed. Featuring a moving load rating of 150kg and a static load rating of 300kg, this set up is ready to handle your next job or adventure.

FEATURES

- Forged in stainless steel
- Matte black paint
- Huge side gullwing doors with sliding vent windows
- Rear brake light
- Filtered, positive pressure air vent
- Universal integrated roof rack tracks
- Front cab slider window
- Easy removal

Available for some American pick-ups.

Ask us about the available accessories for your Smart Cap Canopy!





TRIFOLD

HARD COVER



- Available for most late model utes.
- Lockable (when tailgate locked)
- Tough, smooth vinyl exterior
- Solid ABS interior (can't cut like standard soft covers) - No water pooling!
- Quick, easy clamp on install
- Fold back if carrying loads that extend tray height
- This product is designed to be fitted to standard factory ute tray.
- If fitting to tray with a bed liner, you may need to use part LIK808
- Ask us for a solution if you want to retain your sports bar.





TONNEAU



SOFT COVER



Standard Tray

Have a roll bar, tub rack or cab protector? We can modify the cover to fit with installation at our Auckland or Christchurch locations. Some drilling may be required, will depend on vehicle model, roll bar or cab protector (extra charges apply).



To Suit

Sports Bar



To Suit

Cab Protector

FEATURES & BENEFITS

- Sleek Design, Smooth Modern Appearance
- Hidden clamp & rail system
- UV stabilised vinyl
- Simply Roll it up and clip it back to secure soft cover
- Standard install requires no drilling for most models
- 'No Drill' Installation applies to all standard flush sided double-cab well-side decks
- Clean Lines, no more ugly bungee straps and hooks common with other soft tonneau covers.
- Increase Security - Out of sight, out of mind, conceal contents from view



SPORTS BARS

STAINLESS STEEL

Up-Spec your ute with a sports bar that's practical and enhances the looks of your vehicle. Our sports bars (aka roll bars) are a easy way to add an eye catching and personalised touch to your vehicle.

Spotlight Mount

All Airplex Sports bars are fitted with mounting points for easy installation of spotlights for when you need extra light whilst on duty. These are discrete front mount flush tags that easily allow you to mount an LED light bar or spotlights.



Polished

Stainless Steel



Easy DIY Installation

Install yourself or have our experienced tradesmen mount it in your ute with our full installation service.

The standard bolt kit supplied allows easy fitment to standard factory ute tray. If you have an over rail style liner, we can supply special additional fasteners.



Black

Stainless Steel

- Available in Black or Polished S/S
- Spotlight & LED light bar mount points
- Installation bolt kit included

Available for most ute makes & models



NUDGE BARS

STAINLESS STEEL

Enhance the look of your vehicle while helping to protect the front end from nudges, minor scrapes and scratches that all hardworking vehicles are in danger from on roads, construction sites and other drivers.

Airplex have a range of nudge bars to help protect the front of your vehicle. Sensor models available for vehicles with front sensors.



Polished

Stainless Steel



Black

Stainless Steel



Nudge Bar

with H-Rack

FEATURES

- Robust and generous in size - 3" profile
- Airbag certified
- Spotlight mounts (most models)
- Vehicle specific
- Black powder-coat option available
- Stylish - enhance the look of your vehicle
- Full fitting kit supplied
- 'H' rack only available on select vehicles



WINCH BARS

FRONT & REAR

Every Ironman 4x4 bull bar is carefully crafted from premium grade materials and components to deliver the most comprehensive frontal protection and styling available.

Every Ironman 4x4 Bull Bar is carefully modeled using precision 3D vehicle scanning techniques to achieve optimal cosmetic design whilst providing maximum vehicle collision protection.

The Ironman Deluxe Commercial Winch Bull Bar

Combining the strength and practicality of the Ironman Commercial Bull Bar, featured with the driving light package as used in the Ironman Protector Bull Bar. Providing the ultimate in style and protection, this popular combination is engineered to please and protect.



Features

- Airbag / Winch compatible
- Aerial Mount
- Parker / Indicator included
- A-Frame triple loop design
- Tough polyurethane bumpers
- Driving light mount included
- Steel construction
- Winch compatible, we can supply and install winches too!



Commercial Deluxe

Front Bar



Commercial Deluxe

Rear Bar



TOW BARS

& WIRING LOOMS

Airplex specialise in Ute and 4x4 towbars. These will usually be supplied in pintype removable square hitch style which allows maximum rating and maximum versatility. The ball can be easily removed when not in use, and also allows load extenders and bike racks to be easily and securely fitted as required making the most of your vehicle capability.



Removable Hitch

Square/ Pin Type

- Heavy duty
- Easy to remove if not required
- Maximum rated
- Available for wide range of vehicles
- Easy & securely fit hitch mount accessories such as bike racks



Bolt-on

Welded

- Not easily removable but can be unbolted if required
- Maximum rated for your vehicle
- Available for wide range of vehicles



Fixed Tongue

Welded

- Usually for lower rated towbars or lighter weight vehicles
- Ideal for vans with lower clearances
- Maximum rated for your vehicle
- Not recommended for commercial use

Wiring Looms:

- Vehicle specific tow bar wiring kits available for most vehicles.
- Suitable for CAN-Bus, LED lights and has a weatherproof trailer connector.
- Plug and play for most vehicles available.



SIDE STEPS

FOR UTES

Custom fitted to each vehicle, the side step is heavy duty, chassis mounted for increased strength and protection. In most cases drilling is not required.

Not only do side steps give the vehicle a commanding presence on the road, they protect the side of your car from stone chips, scratches and light side impact accidents.

Aluminium (Flat)

Unpainted or Black



Stainless Steel (Oval)

Unpainted or Black



- Alloy side step using traditional flat step
- Stainless steel in an oval shape with an insert tread
- Black powder-coat option also available in either style
- Heavy duty 'rock slider' style steps available for a limited range of vehicles too
- Available in sizes to fit double cabs and some single or extra/king cab vehicles.



TUB RACK

UTILITY RACKS

The Airplex Universal Ute Tub Rack is a versatile utility system perfect for users looking to carry long loads, roof tents and more.

This is the ideal solution for providing additional storage capabilities to your ute, without the big ticket price of a canopy.



Rolling Lid

Tub-Rack can be mounted:

- Directly to the well-sides of your ute (adapter including with product).
- To the top of your aluminium Hard Lid.
- To the side tracks of your Airplex Rolling Lid



Aluminium Lid

You have the option of using RR201 by itself, or get two in combination with a RR201-SB support bar (pictured right).



Wellside

with RR201-SB

Tub Rack is sold individually.

RHINO-RACK

**PRICE
MATCH
AVAILABLE**

CONDITIONS APPLY

RHINO RACK

ROOF RACKS

Full installation service available

Rhino has a great range of Roof Racks and Roof Rack Accessories including Awnings, Bike Racks, Luggage Boxes, Kayak Carriers, Ski & Snowboard Carriers, Windsurf & Surfboard carriers. Plus Alloy roof Trays, Steel Mesh Baskets ladder Racks Boat loaders and much much more....

- Aerodynamically designed for reduced wind noise
- Stylish design in black or silver.
- Strong aluminium bars
- Fibre reinforced legs for extra durability
- Pad mount, gutter mount, track mount & removable mount options
- Recreational and Commercial applications
- Huge range of accessories available for work and play

Airplex is an authorised supplier & installer for Rhino Rack roof racks.



VORTEX



HEAVY DUTY



PLATFORM



CLAMP MOUNT



TRACK MOUNT



BACKBONE

RHINO-RACK

**PRICE
MATCH
AVAILABLE**

RHINO RACK

ACCESSORIES



Sunseeker

Available in 2m & 2.5m models



Roof Tents

Hard and soft shell options

BIKE, SNOW & STORAGE



Universal Carriers

Perfect for long cargo



Ski & Snowboard Carriers

Options for 1-6 ski's, 1-4 snowboards



Bike Carriers

Roof mount & towbar mount options



Roofboxes

Available in 370L, 410L, 530L



BEDLINER

UNDER RAIL

The Airplex bed liner protects your ute tray from damage when loading & unloading cargo & helps prevent cargo from sliding around while driving. All of our liners are custom moulded to suit each make and model of ute.

BEDLINER - 5 PIECE LINER

FEATURES



All bedliners are supplied with fitting kits

- Non Skid Floor
- Easy Assembly and Installation – 5 Pieces - interlocking
- Lightweight bed liner
- Durable polyethylene material
- High-Density Polyethylene (HDPE)
- Protects your Ute bed from scratches and spills
- 100% UV stable surface

BEDLINER - 1 PIECE LINER

FEATURES



Rail caps can be fitted with under-rail bed liners to protect your tail gate & side rails

- Non Skid Floor
- Drop-in Assembly and Installation
- Lightweight bed liner
- High-Density Polyethylene (HDPE)
- Protects your Ute bed from scratches and spills
- 100% UV stable surface
- Maintenance free



RAIL CAPS

WELL-SIDE

Rail Caps offer protection for the top of the well-sides. Often a vehicle may be supplied with no protection on the top of the well-sides where you often reach over or rest a load.

Rail Caps can be fitted with most under rail style liners or on vehicles with no liner at all. Rail Caps are manufactured from the same tough material as the bed-liner.



Bushwacker - 1 Piece



Airplex - 1 Piece



Bushwacker - 2 Piece



Airplex - 2 Piece



Rail caps are attached with 3M adhesive tape

- 1 piece - for the tailgate only
- 2 piece - for the two sides only
- 3 piece - for the two sides & tailgate



Airplex - 3 Piece



BED MAT

NON-SLIP RUBBER

An Airplex Rubber Bed Mat is designed to protect your ute tray/bed and the load you are carrying. Moulded from heavy duty rubber provide



Bed Mat

Moulded



Bed Mat

Cut (Dimple Texture)



Bed Mat

Cut (Checker plate Texture)

FEATURES

- Prevent scratches
- Reduce dents & dings
- Stop your load sliding around
- Additional grip for dogs or other animals
- Safer transportation of your load
- Can be fitted with or without a bedliner

Moulded mats are available for most popular ute models.

They are moulded to fit to a tray without a tray liner.

Depending on availability, cut mats vary between Dimple & Checker plate materials.

**Don't see a bed liner listed for your vehicle?
Bring in your ute, van or trailer and we can make a custom mat to suit.**



BED SLIDES

DOUBLE CAB

Bed slides make it easier to access tools, equipment, and cargo stored in the bed of the ute. Instead of climbing into the bed or reaching over the sides, you can simply slide the bed out to reach items more conveniently.

BS197

HEAVY DUTY

SWL 400kg



L: 1410mm x W: 1270mm

- Non-skid textured floor
- Outer tie-down track (4 x Tie-downs included)
- Load retaining side walls
- Stops in 4 positions
- Approx. 1m travel distance
- Operate with one hand

BS199

LIGHT DUTY

SWL 100kg



L:1270mm x L:1270mm

- Easy to install
- 6 x tie-down points
- Strong construction
- Smooth running bearings
- Locks at three locations
- Total slide movement 700mm

PLEASE CHECK IT WILL FIT IN THE AREA YOU PLAN TO INSTALL BEFORE ORDERING



DRAWER SYSTEMS



UNIVERSAL DRAWERS

Standard:

Double drawer, LH slide out top.
L: 1300mm W: 1000mm H: 285mm

Low profile:

Double drawer, RH & LH slide out top.
L: 1380mm W: 1000mm H: 230mm

Wing Kit available
to create false floor.
(Additional charges apply)



MODEL SPECIFIC DRAWERS

Load capacity on top: 400kgs
Load capacity per drawer: 80kgs
External height: 310mm

Reinforced aircraft grade aluminium.
Industrial heavy duty drawer slides.
Drawer dividers to keep your
equipment organised.

OTHER DRAWERS

For all drawers and slide out options,
visit our website or scan the QR code





BED EXTENDER

BLACK OR SILVER

The Airplex Bed Extender is a versatile accessory designed to enhance the cargo-carrying capacity of a ute's bed. This extension creates an additional space beyond the truck bed, allowing for the transportation of longer items such as lumber, pipes, kayaks, bicycles, and other oversized or awkwardly shaped cargo.

Universal fitment allows installation in most Ute beds.

Use facing forward in the tray to:

- Tray/bed divider
- Secure loose items in tray
- Tie-down gas bottle or shopping etc
- Prevents items sliding around the tray

Use facing outward on tailgate:

- Extend the usable area of the tray
- Safely carry extended loads

This product requires drilling to be installed in some applications.

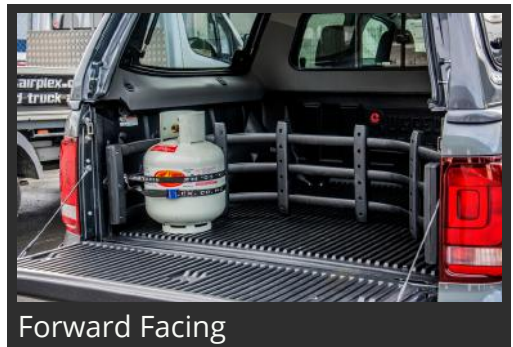

Forward Facing

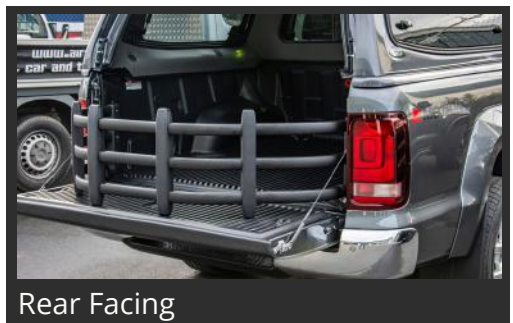

Rear Facing



SWING CASE

RHS OR LHS

THE PORTABLE, SPACE-SAVING STORAGE SOLUTION

The Airplex Swing Case is the perfect accessory to keep your ute's tray organized. Positioned to the sides of your wheel arches, the cases allow you to keep your smaller gear secure and ready to access with ease.

- Swings out for easy access to your tools and gear.
- Take it with you - detach in seconds to take with you on the worksite, or a convenient storage solution on the go.
- Manufactured from durable, light weight ABS plastic.
- Available for most late model ute's.

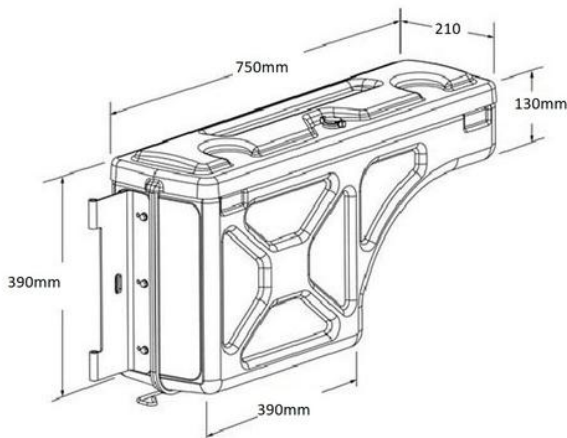

Contact us if you have a bedliner for installation tips & tricks





FENDER FLARES

EXTERIOR

Airplex stocks a range of fender flares for many vehicles. These include both universal style rubber guard extensions and also vehicle specific flared guards. Not only do Airplex Flares look great, they also can help make your vehicle comply with relevant legislation and WOF requirements.

VEHICLE SPECIFIC FLARES



Cosmetic Bolts



Matte Black - Textured



Matte Black - Smooth

UNIVERSAL RUBBER FLARES

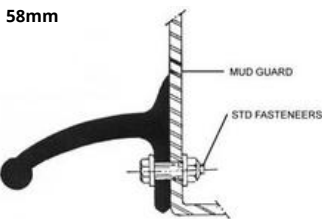

FF444 SIDE MOUNT

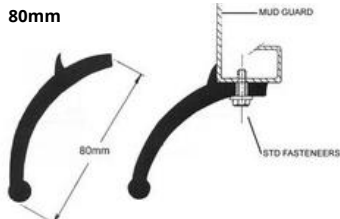

FF462 BOTTOM MOUNT

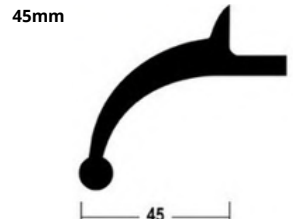

FF431 BOTTOM MOUNT





SEAT COVERS

14OZ CANVAS

Heavy Duty Tailor-made Canvas Seat Covers really are the ultimate in interior vehicle seat protection. A **14oz** Heavy Duty Canvas (Heavy Duty Cotton & Polyester blend) provides 100% rot proof and waterproof protection for your vehicle's interior seating - it's virtually indestructible. These heavy duty seat covers are ideal for the rugged lifestyle of commercial vehicles.

GREY



BLACK



FEATURES

- Tailor-made, guaranteed to fit
- Sold per row (front or rear)
- Made with durable **14oz** Heavy Duty Cotton & Polyester blend
- 100% rot proof and waterproof protection
- Separate headrest covers come as standard
- 5 year guarantee: against faulty materials and workmanship (See packaging insert for full details)
- Split folds & seat belt holes - No worries you'll retain full use and functionality of your seats
- **Available in Black or Grey**



PROUDLY
MADE IN NZ



BONNET GUARDS

UV STABILIZED

BIGGEST RANGE, NO MINIMUM ORDER QUANTITIES

PROUDLY MADE IN NZ BY AIRPLEX!



DARK TINT



CLEAR



MATTE BLACK

- Bonnet Guards are Individually styled to suit each make and model of vehicle.
- All our bonnet guards are manufactured using **UV-stabilised acrylic** to add protection to valuable paint and bodywork.
- Most models are easily installed without drilling and are available in clear or dark tint colour.
- Select models are available in 'matte black, 'carbon-fibre look' and chrome finish.



To find a product to suit your vehicle, use our 'FIT MY VEHICLE' search



HEADLIGHT GUARDS

PROUDLY
MADE IN NZ

UV STABILIZED

Made from high-quality, UV stabilized materials, our headlight protectors are designed to withstand the toughest driving conditions and provide long-lasting protection for your headlights. Whether you're driving on gravel roads, in heavy rain or snow, or on dusty off-road trails, our headlight protectors will keep your headlights safe and intact.

FEATURES

- Headlight guards will extend the life of headlights by protecting them from stones, road debris and general abrasion.
- Even modern polycarbonate lenses need protection from breakage and dulling from abrasion by installing quality Airplex Headlight Guards.
- Headlight guards are simple to fit with no drilling required
- All headlight guards are available in clear acrylic.
- Some are available in tinted and other colours or patterned graphics (depending on make and model of vehicle).

CLEAR



DARK TINT



All non-clear headlight covers are designed and sold for showroom and off-road use only. These will need to be removed when your lights are in use.



WEATHER SHIELDS

DOOR VISORS/ MONSOONS

Airplex designs & manufactures high quality UV stabilized weather shields for cars, 4x4's, trucks & busses. They are designed to help deflect wind and rain from entering your vehicles allowing you to leave the window down whilst driving.



SLIM

DARK TINT (4 PC)



TRADITIONAL

LIGHT TINT (EA)

The slim 'sport' visor style is available for *most* new vehicles and some older vehicles. This product is a dark tint material and is sold as a set.

Most older models are supplied in the traditional NZ larger style weather shield. This shield is a light tint & sold individually.



BIGGEST RANGE & NO MINIMUM ORDER QUANTITIES

EVC

THROTTLE CONTROLLERS

THROTTLE CONTROLLER

UNLEASH THE POWER!

The EVC Throttle Controller is a plug and play throttle controller that gives you complete control over the responsiveness of your vehicle. It does this by providing new points of reference for your throttle mapping, introducing either a sharper or duller throttle curve depending on what mode/setting has been selected.

ECO MODE

ECO mode is designed for economy by reducing the accelerator response time. Also handy when you are on the trails and looking for a bit more throttle control when crawling.

ULTIMATE MODE

Ultimate Mode offers 9 sensitivity levels, this allows the driver to tune the controller to the desired level of sensitivity. Choose level 9 and grip the steering wheel tight or hit level 1 for a gentle smooth acceleration.

AC MODE

Automatic control mode automatically selects the sensitivity level based on pedal pressure. If you are in traffic and accelerating gently the EVC-iDRIVE will automatically choose a reduced level of throttle response.



EVC

BASE MODEL

Ultimate mode, Factory mode, Eco mode, Auto Control mode.



EVCX

ULTIMATE9

Ultimate mode, Factory mode, Eco mode, Auto Control mode.

Ultimate9 mode, Launch mode, Adapt mode, Anti-slip mode, Valet mode, Lock mode.

iOS/ Android & Bluetooth Compatible

EASY DIY INSTALL - OR GET AN AIRPLEX PROFESSIONAL TO DO IT FOR YOU



LIGHTING

DRIVING LIGHTS



- Latest CREE LED Technology
- High output LED driving lights.
- Includes protective face covers
- Sold as a kit or individually
- Available in sizes from 4" to 9"

DRIVING LIGHTS



- Latest CREE LED Technology
- High output LED light bars.
- Includes protective face covers
- Single and Double Row options available
- Sizes in from 10" - 40"

FOG LAMPS OEM STYLE



- Airplex stock a range of fog lamps to fit the original bumper of the vehicle.
- Nissan Navara, Toyota Hilux, Mitsubishi Triton, Holden Rodeo, Isuzu Dmax

HITCH STEP TOWBAR STEP



- Tow bar step with LED and 7 PIN PLUG
- Easily fits to most tow bars with FLAT surface around ball.
- Also available without LEDs.



TAILGATE ASSIST

EASY UP, EASY DOWN

How many times during each day do you open and close your tailgate?
5, 10 maybe 15 times a day?

For commercial use, you have your hands full of heavy equipment, tools and paperwork, balancing it all to open the heavy tailgate. With a Tailgate Assist it makes it all so much easier and lighter.

For the family, it provides easier access to your stuff during all your leisure activities and minimizes the hazards of the heavy tailgate for young children.



Sample image of product
Contents vary between vehicle.

There is no drilling required to install our tailgate assists. The product uses the existing mount points on the vehicle. Installing a Tailgate Assist does not affect the factory warranty on your vehicle as no modification is required.

Tailgate Assist *with* Pro-Lift®

- THE MOST effective Tailgate Assist on the market
- Gas Stay plus Dual Spring
- (most models).
- EASY UP & EASY DOWN
- No drilling to install
- Makes tailgate opening and closing an easy operation
- Makes tailgate safe for all family members
- Gas Stay for hands free slow opening
- Revised spring system for easy close action
- Available on select models

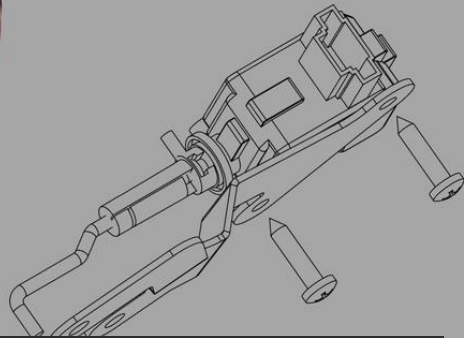

TAILGATE CENTRAL LOCKING

The Airplex Tailgate Lock allows you to sync your tailgate with your existing vehicle remote. The unit works by engaging and disengaging your existing handle when your vehicle locks and unlocks.

Giving peace of mind knowing that when your car is locked, so is your tailgate. The Airplex Tail Lock is the perfect addition to any ute, with or without an existing barrel lock.



FEATURES

- Syncs with your factory remote
- Hidden non-intrusive design
- Works with your factory proximity remote
- Gives ultimate security for your tub
- DIY Installation, no drilling required

KIT INCLUDES

- Actuator, high power, purpose built
- Vehicle specific cust brackets
- Insulated wiring loom
- Factory vehicle plugs
- Universal loom plug
- Installation instructions





PROMOTIONAL ITEMS



PROMO-CAP2

PROMO-BEANIE

PROMO-COOLERBAG

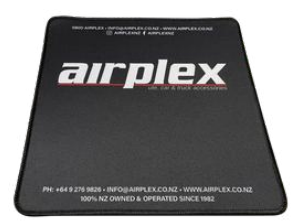

PROMO-AIR-FRESHENER

PROMO-MOUSEPAD

PROMO-MUG



PROMO-BOTTLE-OPENER

PROMO-CAN-HOLDER

PROMO-TAPE-MEASURE

PROUDLY
MADE IN NZ



STONE GUARD

HEAVY TRUCK

Airplex stone guards offer protection from stones and other road debris. Designed and manufactured in New Zealand from high quality aluminum and steel mesh construction. Supplied to motor companies as genuine OEM parts as well as aftermarket.



FEATURES & BENEFITS

- Provides protection for expensive windscreens
- ADR and LSTA compliant mesh
- High quality NZ design and manufacture
- Anti-vibration brackets
- Powder-coated high quality paint finish
- Aluminium & stainless componentry

Construction:

Tried and tested construction over many years has led to the latest New Generation stone guards.

Traditional extruded aluminium rail and galvanised mesh for most models. CAD design and CNC profile cut on select OEM models.

Specify Airplex to ensure you get the best quality product.

Vehicle specific fitment for all vehicles (truck, bus and light commercials). Supplied throughout New Zealand and exported to OEM and aftermarket

SUNVISORS

HEAVY TRUCK

TRUCK EXTERIOR SUNVISOR

Airplex design and manufacture a wide range of sunvisors to suit a range of Japanese and international brand trucks, including FUSO, UD, Nissan, Isuzu, Hino, Foton, JAC, etc.



FEATURES & BENEFITS

- Sunvisors are made from fibreglass and are individually designed to suit each make and model.
- The Airplex sunvisor is the preferred sunvisor for several leading truck manufacturers.
- Many models are supplied as OEM (original equipment manufacture) by the truck brand in New Zealand and several export markets.
- Designed to integrate with the cab
- Protect driver and cab from sun
- Smooth gel coat finish
- Colour match to original factory truck colour
- Enhance the look of the truck

PROUDLY 
MADE IN NZ

AIR KITS & SIDE SKIRTS

HEAVY TRUCK

Save Fuel > Think Aerodynamics.

Wind drag matters! Drag is wind resistance and reducing that drag could spell the difference between a profitable run and the break even point. Fuel prices aren't going to decrease anytime soon so it is beneficial to work out every way possible to save fuel costs and that means decreasing drag whenever possible.

Proper truck aerodynamics is one way to save as much as 6%- 20% (as shown by independent - Isuzu and Freightliner studies) on fuel costs. At 100,000 km per year and today's fuel prices that equates to some very large savings in fuel alone. That's real money in your pocket if you are an owner-operator.

FEATURES & BENEFITS

- Improve fuel efficiency
- Reduce engine & drive train wear
- Reduce truck maintenance
- Improved stability
- Reduced spray
- Great for sign-writing and advertising
- Enhance looks and styling with Airplex' smooth modern designs
- Individually styled to suit each model truck



Most models are available with or without side skirts (cab extenders) for optimum aerodynamics & aesthetics.



WHEEL TRIMS

TRUCK, BUS, COACH & VAN

Our range of trims are manufactured from only the highest grade of stainless steel, meaning they will not rust like cheaper trims which are available on the market. We hold a huge stock in our NZ based warehouse. You will not be disappointed with our vast selection from wheel liners, trim rings and wheel nut covers to our super stylish American simulator jumbo trims and Scandinavian style flat dish trims.

AVAILABLE IN: 15" 16" 17.5" 19.5" 22.5" PROFILES

EXPANSION RING



TAP ON

(FRICTION)



BOLT ON



LUG NUT COVERS



Airplex carries a range of lug nut covers:
LNC32, LNC33, LNC38*41MM
LNC38*52MM, LNC41*43MM
LNC41*49MM, LNC41*63MM

airplex

Still proudly manufacturing in New Zealand for over 40 years!

Airplex Industries Ltd was established in 1982 to manufacture automotive acrylic accessories for the aftermarket & OEM business.

Since then, Airplex has grown to become New Zealand's leading manufacturer and distributor of a wide range of automotive products including ute canopies, nudge bars, bonnet guards, headlight covers, ute hard lids and much more.



SCAN HERE

Airplex Industries Ltd | www.airplex.co.nz

21 Saleyards Rd, Otahuhu, Auckland 1062 | PH: 0800-247-753 | E: info@airplex.co.nz



PROUDLY PARTNERED WITH CVA:

Airplex Industries Ltd are excited to announce our partnership with Canterbury Vehicle Accessories who are the authorized south island distributor and installer.

Canterbury Vehicle Accessories Ltd | www.cva.co.nz

9 Edmonton Road, Hornby, Christchurch 8042 | 0800 500 582 | info@cva.co.nz